

Zeus Alarm BMS Interface

Zeus Medical Gas Alarm Systems
Operation and Maintenance Manual



Published by Pneumatech Medical Gas Solutions

All possible care has been taken in the preparation of this publication, but Pneumatech Medical Gas Solutions accepts no liability for any inaccuracies that may be found.

Pneumatech Medical Gas Solutions reserves the right to make changes without notice both to this publication and to the product which it describes.

Copyright © 2015 Atlas Copco All rights reserved.

No part of this publication may be reproduced, transmitted, transcribed, or stored in a retrieval system or translated into any human or computer language in any form or by any means without the prior permission of Pneumatech Medical Gas Solutions.



Important

Personnel must make themselves familiar with the contents of this manual and the function of the unit before installing, operating or maintaining any Zeus BMS Interface.

Information contained in this manual is correct at the date of publication. The policy of Pneumatech Medical Gas Solutions is one of continuous product improvement. Pneumatech Medical Gas Solutions reserves the right to make changes that may affect instructions in this manual without prior notice.

For any enquiry regarding the servicing or repair of this device, contact the nearest accredited Pneumatech Medical Gas Solutions agent, or communicate directly with:



Pneumatech Medical Gas Solutions
Unit 18 Nuffield Centrum
Nuffield Way
Abingdon
Oxfordshire
OX14 1RL
UK

<http://www.p-mgs.com>

Sales

Tel: 44 (0) 1235 463010
Fax: 44 (0) 1235 463011
sales@p-mgs.com

Spares

Tel: 44 (0) 1235 463053
Fax: 44 (0) 1235 463011
spares@p-mgs.com

Service

Tel: 44 (0) 1235 463051
Fax: 44 (0) 1235 463011
service@p-mgs.com

Any complaints about the products or services provided by Pneumatech Medical Gas Solutions, please give as much of the following information as possible:

Product Part Number
Lot/ Batch Number
Approximate date of purchase
Apparent fault.

Complaints

T: 44 (0) 1235 463010
F: 44 (0) 1235 463011
complaints@p-mgs.com













Table of Contents

0. Safety, Storage and Handling Data	3
0.1 Symbols	3
0.2 Environmental Transport and Storage	3
0.3 Cleaning	3
0.4 Environmental Protection	3
0.5 Electromagnetic Interference	4
0.6 Electrical Details	4
1. DESCRIPTION AND OPERATION	4
1.1 Introduction	4
2. INSTALLATION	4
2.1 First Fix	4
2.2 Second Fix	4
3 CONFIGURATION AND OPERATION	5
3.1 Configuration	5
3.2 Operation	5
3.3 Troubleshooting	5
4 WIRING DIAGRAMS	6
4.1 Output Wiring	6
4.2 Data Cable Wiring	6
5 SPARE PARTS	6

0. Safety, Storage and Handling Data

0.1 Symbols

The following symbols apply to this product and are used in these instructions and on the product in question. The meanings of these symbols are as specified below: -

	Read instructions
	Warning - dangerous voltage
	Ambient temperature range
	Ambient humidity range
	Ambient pressure range
	Date of manufacture
	Caution - system alarm
	Power on
	Mute switch
	Test lights
	Protective earth
	Alternating current

0.2 Environmental Transport and Storage

Conditions & Operating Conditions

Min ambient temperature - 0 degrees Celsius

Max ambient temperature - 40 degrees Celsius

Min relative humidity (non-condensing) - 10%

Max relative humidity (non-condensing) - 95%

Atmospheric pressure range - 70-110 kPa

0.3 Cleaning

The alarm cover and fascia should be wiped over with a damp cloth frequently to remove any dust or foreign substances.

0.4 Environmental Protection

Discard the unit and/or components in any standard refuse facility. The unit does not contain any hazardous substances.

0.5 Electromagnetic Interference

Ensure any input and data cables are physically separated from other mains and data cables.

0.6 Electrical Details

WARNING... It is necessary to check the integrity of the power source for safety at regular intervals. These checks should be carried out annually and replacement power supplies used is necessary.

Power source

Mains operated using 110/230V, 50/60Hz, alternating current, from an essential circuit. Please see labelling inside unit for correct voltage.

Current requirements:
3.0 amps

Type of protection against electric shock:
Class 1 (Mains supplied equipment using a protected earth)

Mode of operation:
Continuous (equipment may be left switched on indefinitely)

Degree of protection against ingress of liquids:
IPX0 (Not protected)

Degree of mobility:
Permanently installed (This unit is electrically connected by permanent means)

Degree of protection:
Type B (no Applied Part or with and Applied Part not designed to meet F type (floating) requirements)

Degree of protection against flammable anaesthetic mixtures:
Not protected (not suitable for use with flammable gases)

Rechargeable Battery:
The rechargeable battery (ref. 6000157) should be replaced every 5 years.

1. DESCRIPTION AND OPERATION

1.1 Introduction

The Zeus BMS Interface has been designed to complement the Zeus 15 Alarm. It allows alarm conditions to be presented as normally open relay contacts to an external system, such as a BMS or auto-dialler.

The Zeus BMS Interface fits into the same enclosure as a normal Zeus 15 alarm, and the configuration is very similar.

2. INSTALLATION

2.1 First Fix

The first fix back box (part number 1826561) should be installed in the appropriate place, and the power supply cables, data cables and relay output cables should be run to the enclosure using appropriate cables and conduit.

WARNING:-

BEFORE CARRYING OUT ANY WORK, ENSURE THAT THE POWER SUPPLY IS OFF AND CORRECTLY ISOLATED. THE ELECTRICAL POWER SUPPLIES MUST BE CONNECTED BY A QUALIFIED ELECTRICIAN. ALL WIRING MUST BE IN ACCORDANCE WITH CURRENT IET WIRING REGULATIONS.

WARNING:-

ENSURE THAT ADEQUATE PRECAUTIONS ARE TAKEN WHEN HANDLING PCB'S, BOTH FOR PHYSICAL DAMAGE AND STATIC DISCHARGE.

Connect the mains cable to an un-switched fused connection unit fused at 3 amps.

2.2 Second Fix

Once the second fix is to be installed, install the Power PCB into the back box using the spacers, nuts and washers provided. Connect the cables to the PCB. Wiring diagrams are provided in section 4.1

Ensure that the A and B wires are not transposed, and that the connections to the relay contacts are correct. The mains cover should be carefully re-fitted after installation of the mains cable.

Fit the door/relay board assembly to the back box using the screws provided, and connect the two ribbon cables to the power PCB.

3 CONFIGURATION AND OPERATION

3.1 Configuration

The Zeus BMS Interface has 6 rotary switches. These function as follows:

- SW1 – Channel 1 gas number (0 is OFF)
- SW2 – Channel 2 gas number (0 is OFF)
- SW3 – Channel 3 gas number (0 is OFF)
- SW4 – Channel 4 gas number (0 is OFF)
- SW5 – Channel 5 gas number (0 is OFF)
- SW7 – Panel ID

There are also 2 DIP switches on SW6.

SW6:1 is MSID, and when “ON” adds 16 to the ID number of SW7.

SW6:2 is not implemented on the Zeus BMS Interface MKII.

Rotate the switches to the required position, and re-set the BMS Interface using the “RESET” button on the PCB.

If everything is correctly connected the red ‘RX’ LED should start flashing, indicating the correct reception of data. The green ‘HB’ LED should also start flashing, indicating the system is healthy.

The relay contacts will switch to indicate the current status of the configured gas channels.

3.2 Operation

There are no specific operational policies required for the Zeus BMS Interface. It is designed to be installed permanently and will operate without user intervention.

If necessary, the front fascia can be cleaned with a damp cloth, with mild detergent if required.

3.3 Troubleshooting

The Zeus BMS Interface has been designed for trouble-free operation. Most problems encountered are caused by incorrect cable types, or poor termination of cables.

In the event of a fault, reset the internal software by pressing the “reset” button on the PCB and check for normal operation. A reset may also be required after an extended power outage when the battery has discharged.

The HB LED on the PCB will give an indication of the state of the internal software and hardware. Under normal operation, the LED should flash once per second, with an equal on/off time (50% duty cycle). If the processor has

detected a power failure, the LED will flash at a 10% duty cycle. If the LED is permanently on or off, a problem is indicated with the power supply or software.

There are a number of test points that can be used in conjunction with a multi-meter to check the power supply voltages. These are detailed in the table below:

Test Point	Voltage (reference point)
3	2.5 volts (TP8)
4	5.0 volts (TP8)
5	5.0 volts (TP8)
6	15 volts (TP8)
7	15-20 volts (TP8)
8	0 volts (main)
9	5 volts (TP10)
10	0 Volts (comms)

Table 1 - Test Point Data

If the voltages in the table are not present at the test points, then a faulty PCB is indicated. Check the two low side fuses (F2 for TP’s 1-7, and F3 for TP10, both 500mA) and the high side fuse F1 (1A). Also check the fuse in the fused spur supplying the alarm, and any other upstream protection devices.

If the voltages are correct and the HB LED is still not indicating correctly, the software installed in the processor chip may need updating. Contact Staveley for more information on this procedure.

A replacement power PCB is available under part number 2005201 (230V)

If an individual condition is showing a fault instead of a normal condition, the relay on the relay board may be faulty. Exchange with a relay on an unused column, or purchase a replacement relay.

Relays are Hamlin part number HE751A2410 and are available from Farnell Electronic Components, stock number 9561854.

If there is still a fault, the relay board is faulty, and a replacement must be purchased from BeaconMedæus. See the spare parts list on page 6 for more details.

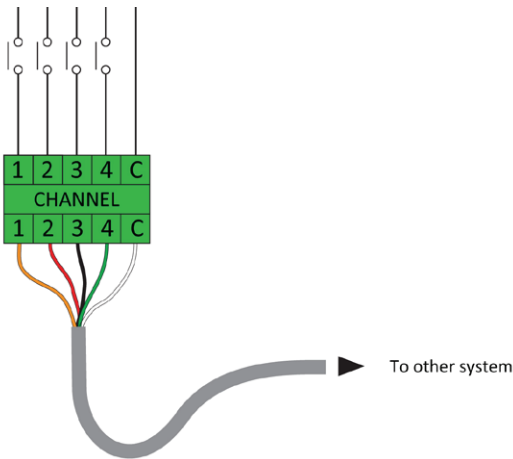

5 SPARE PARTS

The Zeus BMS Interface should give many years of service without the need for spares, however, if parts are needed, a complete spares diagram is shown opposite and detailed parts list in the table below.

Table 2 - Spare Parts

Part ID	Description	Part Number
1	M4 x 12 Pan Head Screw	on req.
2	Power PCB Spacer	on req.
3	M3 Nylon Washer	on req.
4	Earth Link Wire	on req.
5	Zeus Backbox	6000143
6	Relay PCB Spacer	on req.
7	Zeus Relay PCB (in cover)	6000172
8	M3 Nut	on req.
9	M3 Steel Washer	on req.
10	M4 Steel Washer	on req.
11	Zeus Key Kit	6000162
12	Zeus Power PCB (in base)	6000243
13	Zeus Cover Assembly	6000173
-	Rechargeable battery	6000157
-	1 A fuse (ref. F1)	6000160
-	500 mA Fuse (ref. F2 and F3)	6000159

4 WIRING DIAGRAMS

4.1 Output Wiring

The BMS Interface should be wired according to the diagram below. The relay contacts are volt-free and rated to 50V, 0.5A maximum.

Figure 1 - Standard Wiring

Please note that it is not possible to common the faults together at the BMS Interface. When alarm conditions are “normal”, the appropriate contacts are closed.

4.2 Data Cable Wiring

The data cable should be wired in a continuous “bus” type pattern, as shown in the diagram opposite Rings, radial circuits or “T” junctions are not supported.

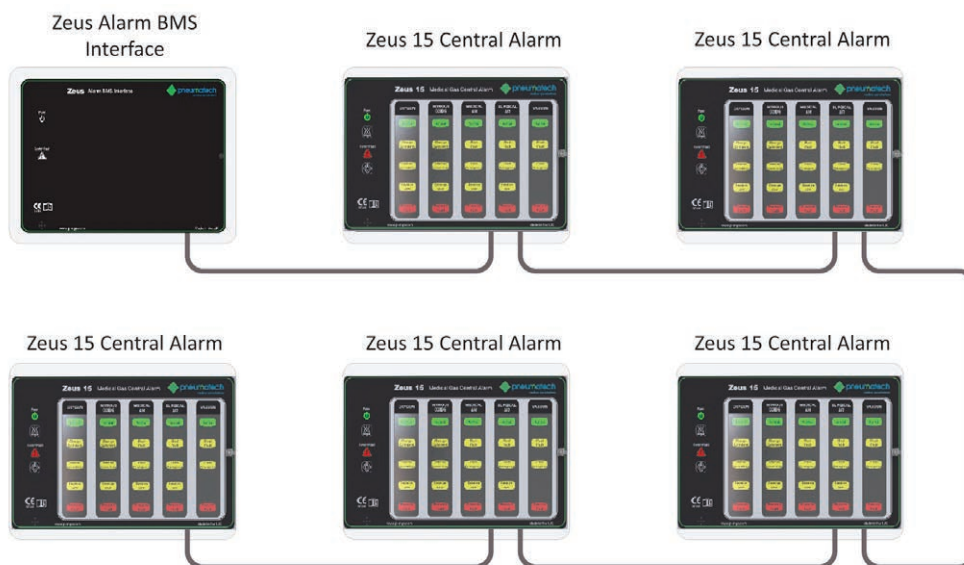
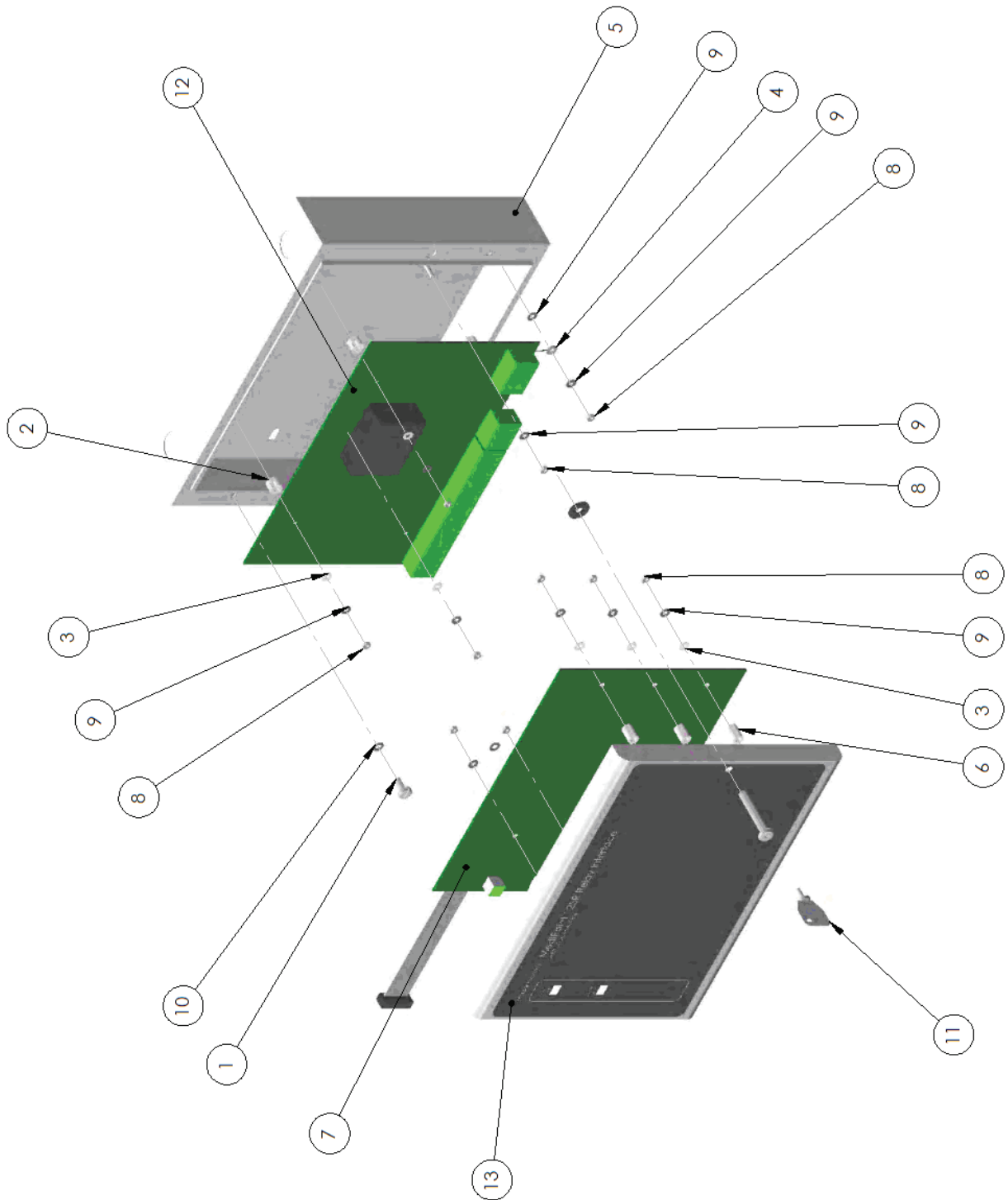

Figure 2 - Zeus BMS Spare Parts Diagram



Pneumatech Medical Gas Solutions
Unit 18 Nuffield Way
Abingdon
Oxfordshire
OX14 1RL UK

Sales

T: 44 (0) 1235 463010
F: 44 (0) 1235 463011
sales@p-nmgs.com

Spares

T: 44 (0) 1235 463053
F: 44 (0) 1235 463011
spares@p-mgs.com

Service

T: 44 (0) 1235 463051
F: 44 (0) 1235 463011
service@p-mgs.com

